

VOLUMEN (l)  
VOLUMEN (l)

MAX. OBREMENITEV (Kg)  
MAX. OBTEREČENJE (Kg)

OBREMENITEV TAL (Kg/m<sup>2</sup>)  
OBTEREČENJE PODA (Kg/m<sup>2</sup>)

245

570

320

- – Prostor za el. vodnik 3 x 2,5 mm<sup>2</sup>, dolžine cca 1m.
- Mjesto za el. vodnik 3 x 2,5 mm<sup>2</sup>, dužine cca 1m.
- – Prostor za el. vodnik 1 x 6 mm<sup>2</sup> za ozemljitev, dolžine cca 1,5m.
- Mjesto za el. vodnik 1 x 6 mm<sup>2</sup> za ozemljenje, dužine cca 1,5m.
- – Prostor za odtok ø 50 mm
- Mjesto za odtok ø 50 mm

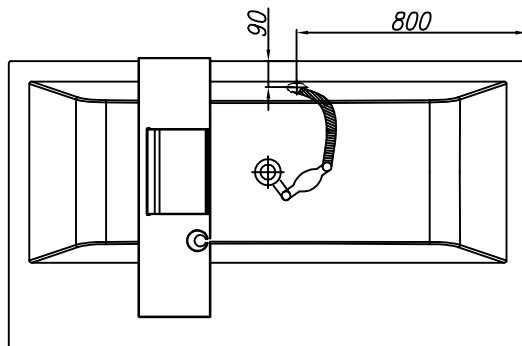



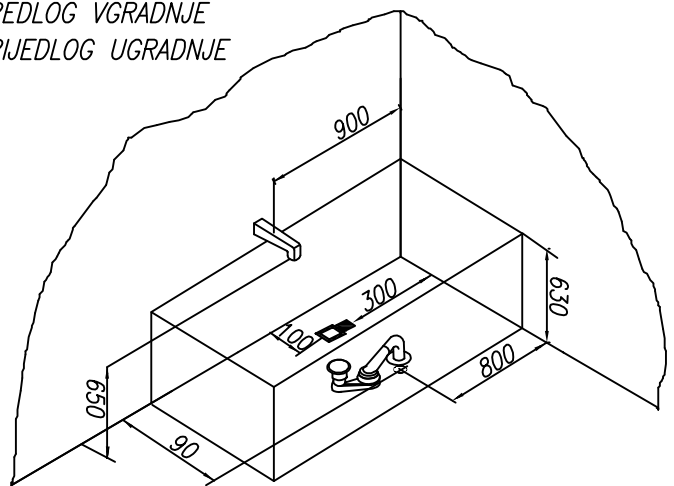

**PREDLOG VGRADNJE  
PRIJEDLOG UGRADNJE**



Kopalna kad iz KERROCK-a, FS – samostoječa.

Kada za kupanje iz KERROCK-a, FS – samostoječa.

- |  |  |   |  |  |
|--|--|---|--|--|
|  - VODNA ČRPALKA<br>- CRPKA ZA VODU        |  - VODNE ŠOBE<br>- VODENE MLAZNICE  |  - REGULATOR ZRAKA<br>- REGULATOR ZRAKA        |  - ELEKTRONSKA STIKALA<br>- ELEKTRONSKI PREKIDAČI         |  - ARMATURA IN TUŠ ROČICA<br>- PIPA I TUŠ                 |
|  - ZRAČNI KOMPRESOR<br>- ZRAČNI KOMPRESOR |  - ZRAČNA ŠOBA<br>- ZRAČNA MLAZNICA |  - PNEVMATSKO STIKALO<br>- PNEVMATSKI PREKIDAČ |  - LUČ ALI CHROMOTERAPIJA<br>- SVJETLO ILI CHROMOTERAPIJA |  - PREKLOPNIK ZA MIKROŠOBE<br>- PREKIDAČ ZA MIKROMLAZNICE |

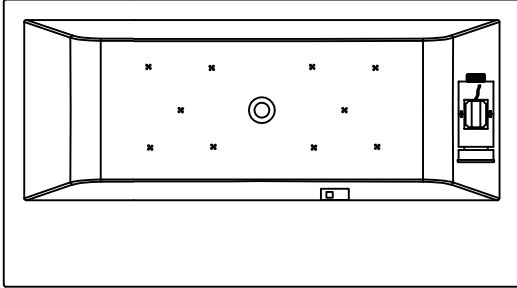

ZRAČNI MASAŽNI SISTEM

- ZRAČNI KOMPRESOR P=800W
- ELEKTRONSKO STIKALO
- 10 ZRAČNIH ŠOB

ZRAČNI MASAŽNI SISTEM

- ZRAČNI KOMPRESOR P=800W
- ELEKTRONSKI PREKIDAČ
- 10 ZRAČNIH MLAZNICA

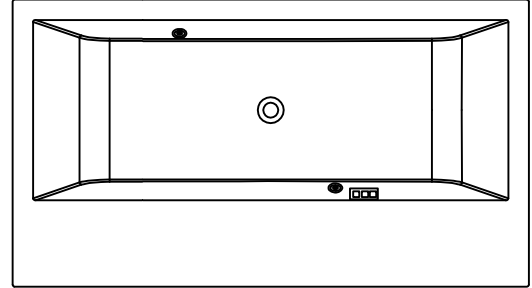

- CHROMOTERAPIJA

- CHROMOTERAPIJA